

Dust Cover( Bellows)

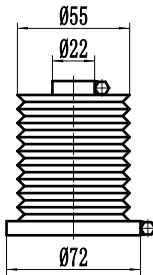

Top Plate

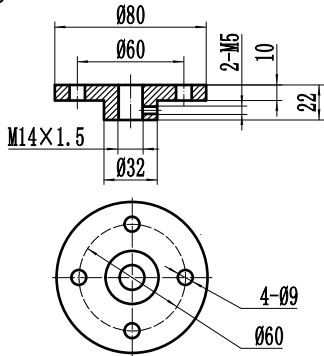

Plain End

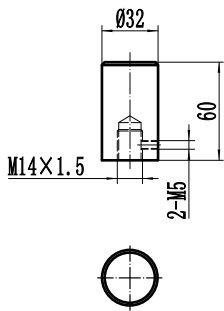

Clevis End

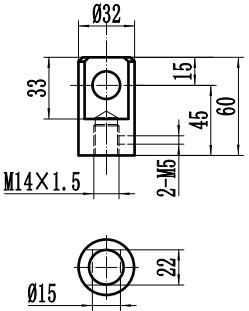

Installation diagram

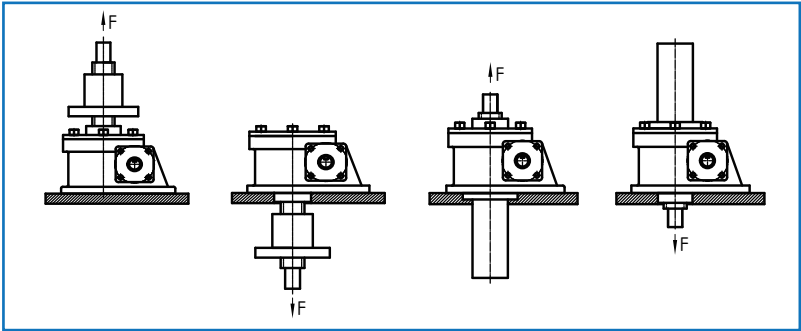

Flange Input  
Can be customized

Motor base number	J2
63B5	104
71B5	111
80B5	121