

WANSHSIN SPEED CONTROLLER

INSTALLATION INSTRUCTION

Digital Display Single Phase WS-L Series



Strengths:

- *Single Chip Microcomputer technical, Multifunction, High Reliability;
- *Digital display menu which is more convenient for parameter setting;
- *It can show the RPM and RATIO. Customers can set the ratio themselves;
- *Fasten time and reducer time is adjustable;
- *The motor rotation direction can be controlled by the Digital display speed controller or External signal control.
- *It will be protected automatically if the motor is blocked off and cannot work.

Drawing of the speed controller:

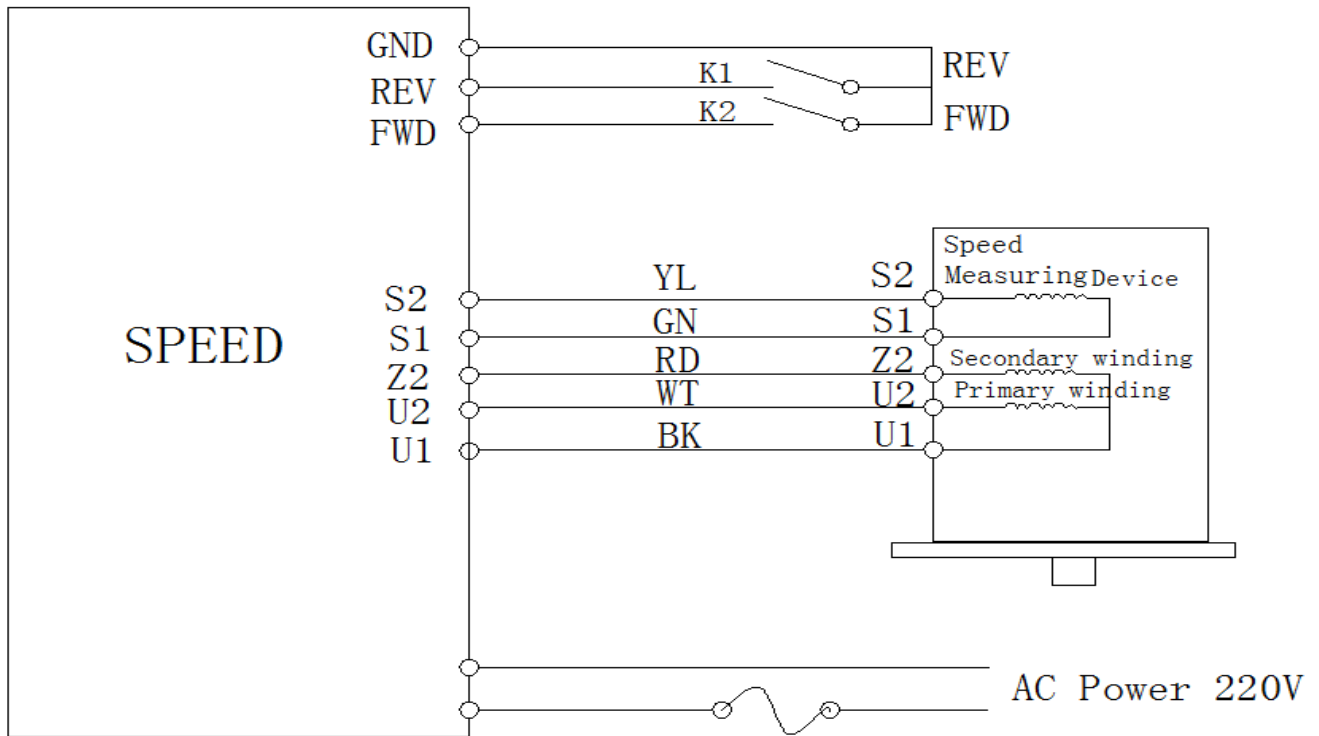

YL- Yellow, GN-Green, RE-Red, WT- White, BL-Blue, BK-Black, BR-Brown.

Speed measuring Device, Secondary winding , Primary winding.

Installation and processing diagram of speed control panel

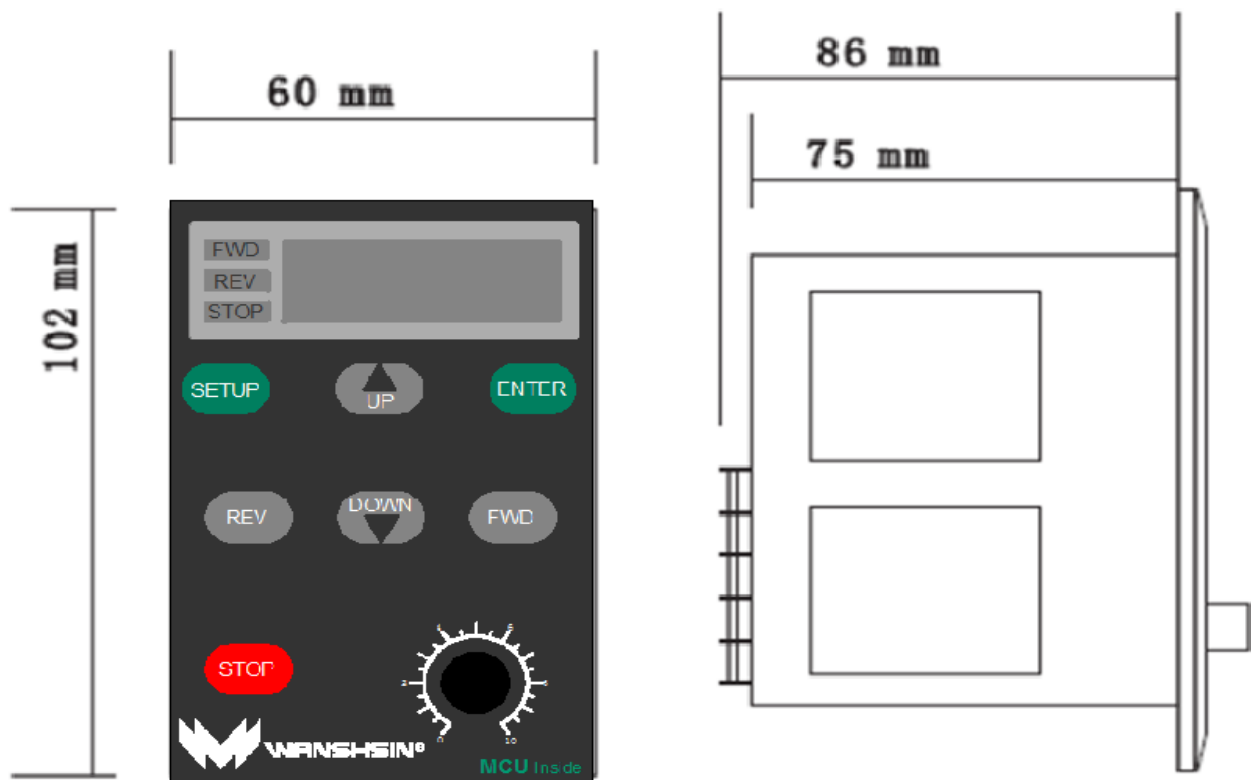

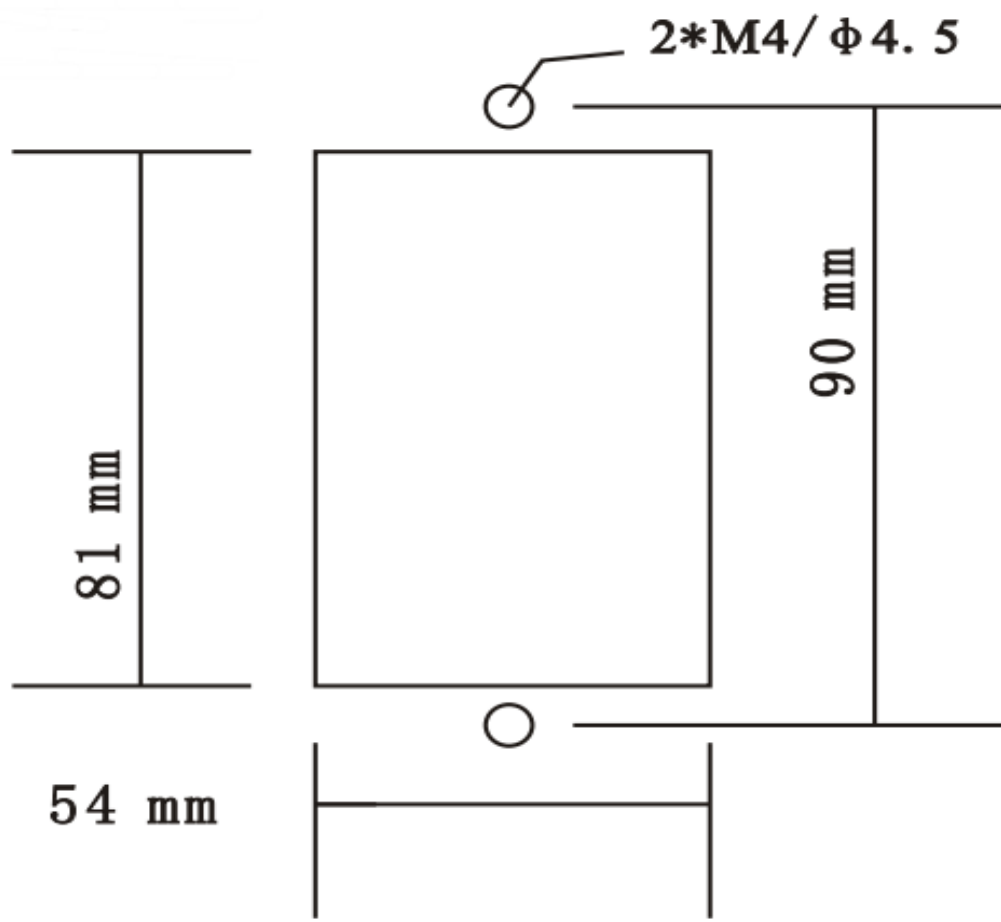

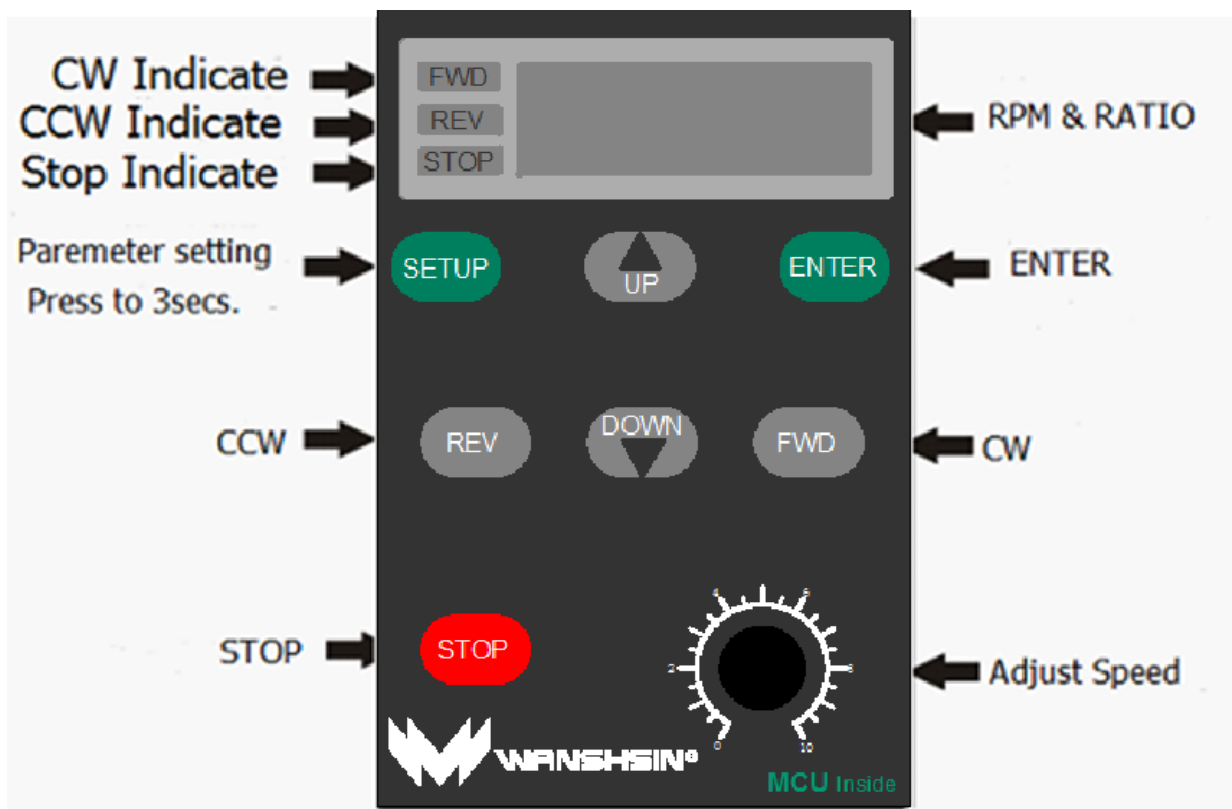

HOW TO USE









Pay attention: It will work under the digital display speed controller control mode. Please make the operation control mode to the digital display speed controller control mode.

HOW TO USE PARAMETER SETTING

1, When the motor stops working, please press "设置/SETUP" over 3 seconds, it will say "C100".

2, Press  and  will make the "C100" to "C123". Then press , it will say "F-01".



3, Press  and  to make the mode you want (such as "F-06"). Then Press .

4, Press  and  to make the parameter as you want (such as to make "1" to "2"), then press .

5, If it says "END", it means it has been saved after the adjustment. It will go to the next part automatically. If it says "Err", it means the parameter is wrong. Please reset it.

6, If all the parameter is finished, please press , then you will be out of the setting up menu. It is before the setting up states.

PARAMETER DESCRIPTION

parameter	Parameter Function	Setting Range	Factory Default
F-01	Display Shows	1.Motor RPM Setting 2.Ratio Setting	1
F-02	Ratio Setting	1.0-999.9	1.0
F-03	Working control mode	1.Controlled by digital display, it will no memory; 2.If it is connected with the external switch, the  INVALID. 3.If it is connected with the external switch, the  WORKING. 4.Digital display key controlled, it will be remembered.	1

Parameter	Parameter Function	Setting Range	Factory Default
F-04	Rotate Way	1.Enable CW/ CCW 2.CW available, CCW Forbidden. 3.CCW available, CW Forbidden.	1
F-05	Rotate Way	1.CCW Forbidden 2.CCW available	1
F-06	Speed Adjust Way	1.Panel key ▲ ▼ 2.Panel Knob	1
F-07	Maximum Speed	500-3000	1400
F-08	Minimum Speed	90-1000	120
F-09	CW Start Accelerate Time	0.1-10.0 Sec.	1.0
F-10	CW STOP WAY	1.Free to stop 2.Decelerate slowly to stop	1
F-11	CW STOP Decelerate time	0.1-10.0Sec.	1.0
F-12	CCW Start Accelerate Time	0.1-10.0Sec.	1.0
F-13	CCW STOP Way	1.Free to stop 2.Decelerate slowly to stop	1

F-14	CCW STOP Decelerate Time	0.1-10.0Sec.	1.0
F-15 to F-28 is the Factory Default			
F-29	RESET	1.NO 2.Yes	1

PARAMETER DETAILS



F-01	Content	1. Motor RPM Setting 2. Ratio Setting	1
------	---------	--	---



Ratio value setting = Motor RPM / RATIO

F-02	Ratio	1.0-999.9	1.0
------	-------	-----------	-----



According to the ratio setting display. It will show the target value.

F-03	Running Control Way	1. Panel control, without memeroy 2. External switch control, Panel stop key unwork. 3. External switch control, Panel stop key workable 4. Panel Control, memeroy	1
------	---------------------------	---	---

Choose "1", from Panel  /  turn off the speed controller and then turn on, Motor is in the stop state;

Choose "4", from Panel  /  , turn off the speed controller and then turn on the speed controller. The speed controller will save before the stop state. For example, if turn off the speed controller and it is CW, turn on the speed controller and it will be CW. Please be careful while choose this function;

Choose external Switch control, from panel  /  to connect switch K1 AND K2 Switch to control the motor. K1 AND K2 CAN CNONNECT WITH PLC to control directly.

When the  is workable and the External Switch K1 AND K2 is still on, press  to stop the motor. If  is not valid, please turn off the K1, K2 to stop the motor.

F-04	Rotate Way	1. CW AND CCW available 2. CW available, CCW forbidden 3. CCW available, CW forbidden	1
------	------------	---	---

Please restrict motor rotate direction to avoid design faults or accidents.

F-05	Rotate Direction	1. CCW Forbidden 2. CCW Available	1
------	------------------	--------------------------------------	---

It is no need to change the motor wiring. The motor rotate direction can be changed at will.

F-06	Speed Adjust	1. Panel ▲ ▼ 2. Panel Knob	1
------	--------------	-------------------------------	---

Choose "1", press ▲ ▼ The speed controller motor is in maximum or minimum RPM.

Choose "2", please use the panel knob to adjust the motor speed. The panel knob automatically matching speed from 0 to the maximum.

F-07	Maximum RPM	500-3000	1400.0
------	-------------	----------	--------

Restricting the motor maximum RPM to avoid the motor over speed.

F-08	Minimum RPM	90-1000	120.0
------	-------------	---------	-------

Restricting the motor minimum RPM to prevent the motor from speed instability, super heat or overload and so on due to low speed running.

F-09	CW Start Accelerate Time	0.1-10.0Sec.	1.0
------	--------------------------	--------------	-----

If the accelerate time is longer, the motor starts smoothly and start will be longer. Otherwise, accelerate time is shower, the motor starts faster and large range of motion.

F-10	CW Stop Way	1. Free to Stop 2. Decelerate slowly to stop	1
------	-------------	---	---

Choose Free to stop. If the motor stop time is short, we can choose free to stop. Change the F-11 Value setting, we can change the motor stop time.

F-11	CW Stop Decelerate Time	0.1-10.0Sec.	1.0
------	-------------------------	--------------	-----

F-10 Choose "2", the menu is workable.

F-12	CCW Start Accelerate time	0.1-10.0Sec.	1.0
------	---------------------------	--------------	-----

Accelerate time sets longer, the motor will start smoothly, start time longer. Otherwise, the accelerate time is shorter, the motor start faster, the range of motion is bigger and the accelerate time is short.

F-13	CCW Stop Way	1. Free to stop 2. Decelerate slowly to stop	1
------	--------------	---	---

Choose Free to stop. If the motor stop time is short, we can choose free to stop. Change the F-11 Value setting, we can

change the motor stop time.

F-14	CCW Stop Decelerate Time	0.1-10.0Sec.	1.0
-------------	---------------------------------	---------------------	------------

F-13 Choose "2", the menu is workable.

F-29	Factory Default	1. Retain the existing value 2. Factory Default	1
-------------	------------------------	--	----------

Choose "2", the system will restore all changed parameters to factory setting.

Fault Remove

Fault Cases	Possible Problems	Handling Methods
No Power	1、 The power line doesnot connect well.	1、 Check the power line and the power socket. 2、 Contact the agent.
Display Er-1	1、 Overload and lock-rotor. 2、 The connection between the speed controller and the motor.	1、 Check the load and the conditions of the motor. 2、 Check the wiring of the motor and reset.